

Article number: 12347000050500
Description: KLEE-coil 347 000 050.500
M 5 St. steel 1.4305

Measures

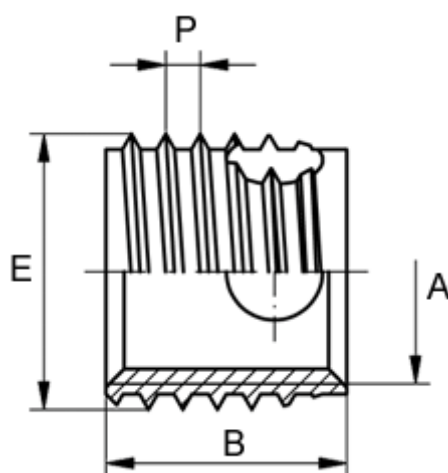

Female thread A	= M5
Length B	= 7
Male thread E	= 6.5
Min hole depth blind hole	= 9
Pre-drilled max	= 6.2
Pre-drilled min	= 6.1
Thread pitch P	= 0.80
Type	= 347 000 050 ...